

BASE PLATES

MA SERIES 油路板

◆ SUBPLATE 底板

1	2	3	4
M02	03	B	1

1 Mounting Size

底板尺寸

M02= 1/4"(6mm)

ISO CETOP3

DIN NG 6

NFPAD03

2 Port Size

口徑

02: 1/4"

03: 3/8"

3 Port Location

口徑位置

B: Bottom 底部

S: Side 側邊

SB: Side & Bottom
側邊與底部

4 Piping Threads

相關管稱

1P: PT

2N: NPT

3G: PF(G)

4A: SAE

5B: BSP

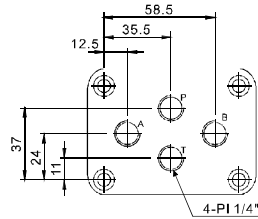
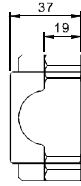
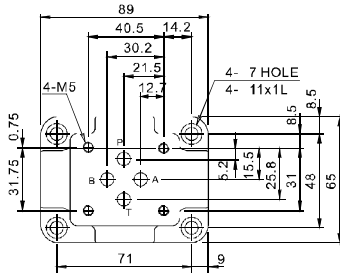

◆ SUBPLATE 底板

1	2	3	4
M03	03	B	1

1 Mounting Size

底板尺寸

M03= 3/8"(9mm)

ISO CETOP5

DIN NG 10

NFPAD05

2 Port Size

口徑

03: 3/8"

04: 1/2"

3 Port Location

口徑位置

B: Bottom 底部

S: Side 側邊

SB: Side & Bottom
側邊與底部

4 Piping Threads

相關管稱

1P: PT

2N: NPT

3G: PF(G)

4A: SAE

5B: BSP

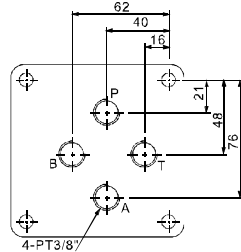
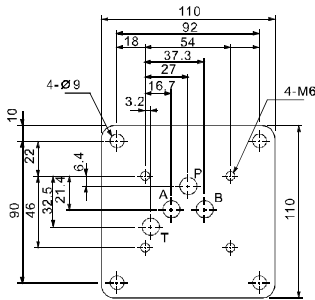

E
MA

◆ MODEL 型 式

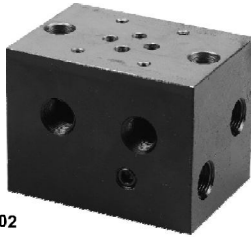

MA-02



MA-03

HYDRAULIC SIGN 液壓符號

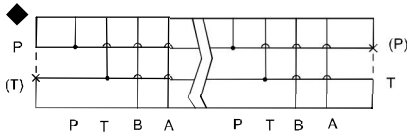

◆ SPECIFICATIONS 規 格

MODEL 型 式		D	E	N	M	L	(kg)
MA-02-2E	1	PT 3/8"	M5x0.8P	2	50	130	5.1
	2	NPT 3/8"	#10-24UNC				
MA-02-3E	1	PT 3/8"	M5x0.8P	3	100	180	7.1
	2	NPT 3/8"	#10-24UNC				
MA-02-4E	1	PT 3/8"	M5x0.8P	4	150	230	9
	2	NPT 3/8"	#10-24UNC				
MA-02-5E	1	PT 3/8"	M5x0.8P	5	200	280	10.9
	2	NPT 3/8"	#10-24UNC				
MA-02-6E	1	PT 3/8"	M5x0.8P	6	250	330	12.8
	2	NPT 3/8"	#10-24UNC				
MA-02-7E	1	PT 3/8"	M5x0.8P	7	300	380	14.7
	2	NPT 3/8"	#10-24UNC				

MODEL 型 式		C	D	E	N	M	L	(kg)
MA-03-2E	1	PT 3/4"	PT 1/2"	M6x1P	2	75	185	13.8
	2	NPT 3/4"	NPT 1/2"	1/4-20UNC				
MA-03-3E	1	PT 3/4"	PT 1/2"	M6x1P	3	150	260	19.5
	2	NPT 3/4"	NPT 1/2"	1/4-20UNC				
MA-03-4E	1	PT 3/4"	PT 1/2"	M6x1P	4	225	335	25.0
	2	NPT 3/4"	NPT 1/2"	1/4-20UNC				
MA-03-5E	1	PT 3/4"	PT 1/2"	M6x1P	5	300	410	31.0
	2	NPT 3/4"	NPT 1/2"	1/4-20UNC				

BASE PLATES

MA SERIES 油路板

◆ HOW TO ORDER 辨認說明

1	2	3	4	5
MA	02	5E	1P	A
MA	03	5E	1P	A

1 VALVE SERIES 系列名稱

MA= Base Plates for Modular Valves

2 SUBPLATE MOUNTING SIZE: 補厚口徑

02 = 1/4"(6mm) 03 = 3/8"(9mm)
 ISO CETOP3 ISO CETOP5
 DIN NG 6 DIN NG 10
 NFPA D03 NFPA D05

3 QUANTITY OF VALVE CONNECTION 閥瓣數

- 1 : 1 CONNECTIONS 瓣
- 2 : 2 CONNECTIONS 瓣
- 3 : 3 CONNECTIONS 瓣
- 4 : 4 CONNECTIONS 瓣
- 5 : 5 CONNECTIONS 瓣

● All of with Screws it's Cent meter Size and If required Inch Size

所附螺絲皆為公制標準規格品，若需英制螺絲請另外備註說明。

4 THREAD TYPE OF JOINT OPEN 接口螺紋形式

1P : PT 4A : SAE
 2N : NPT 5B : BSP
 3G : PF(G)
 THREAD 螺紋

5 OUTLET SECTION 出油側

A : A . B Port outlet section at "A" side

A . A . B 出油側在 "A" 邊

B : A . B Port outlet section at "B" side

B . A . B 出油側在 "B" 邊

◆ DIMENSIONS 外型尺寸圖

MA-02-1E

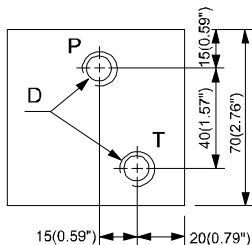
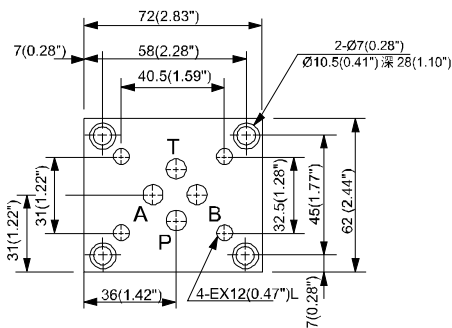
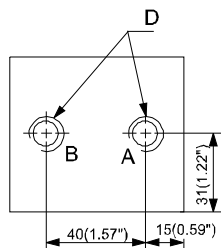

MODEL 型	MA-0-1E-1	MA-02-1E-2
D	PT 3/8"	NPT3/8"
E	M5x0.8P	#10-24UNC

◆ DIMENSIONS 外型尺寸圖

MA-02- * E

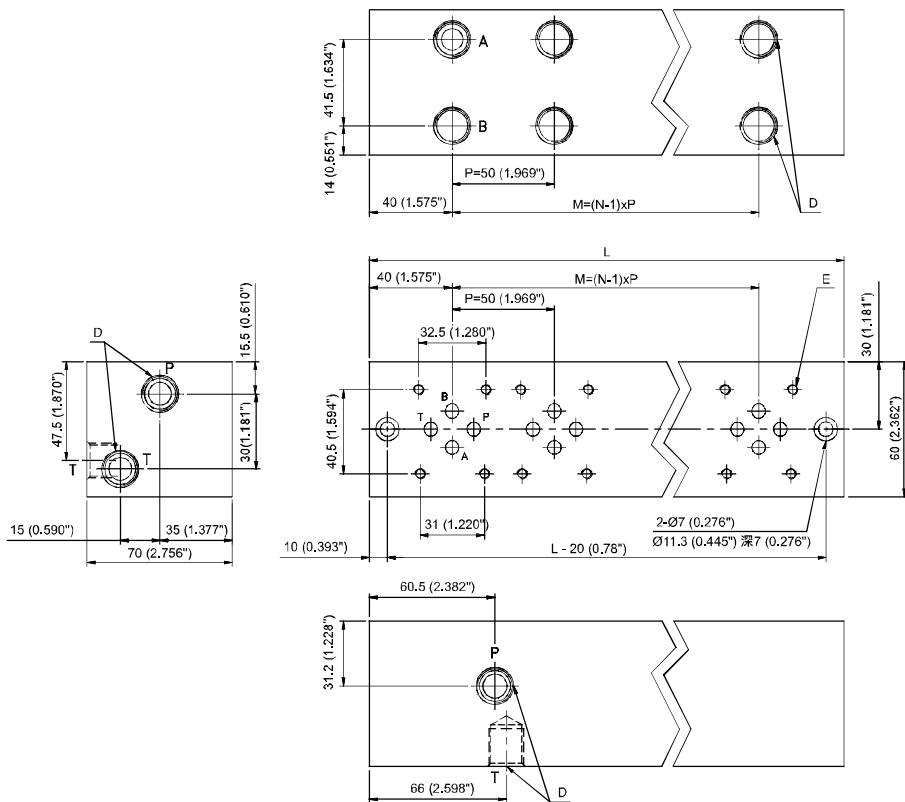

BASE PLATES

MA SERIES 油路板

◆ DIMENSIONS 外形尺寸图

MA-03-1E

MODEL 型 式	MA-03-1E-1	MA-03-1E-2
C	PT 3/4"	NPT 3/4"
D	PT 1/2"	NPT 1/2"
E	M6x1P	1/4 20UNC

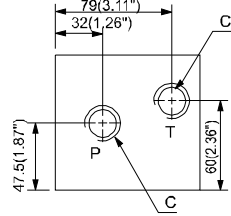
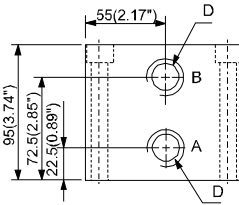
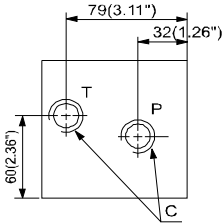
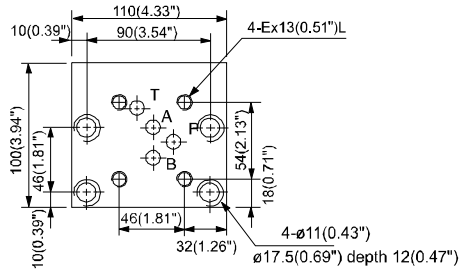

MA-03- * E

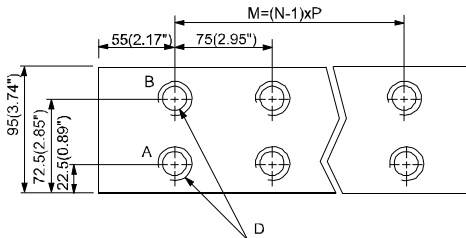
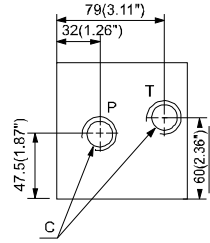
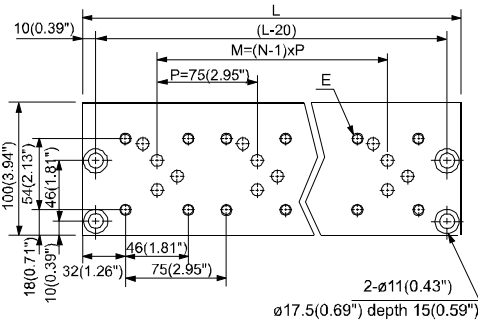
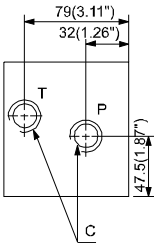

E
MA