

◆ MODEL 型 式

VSV12-23

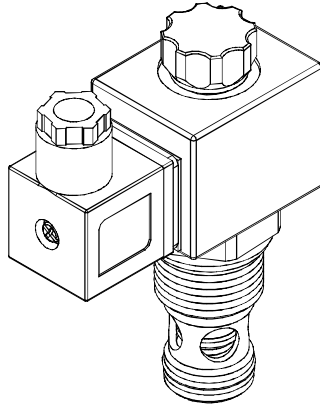

◆ PERFORMANCE 特性曲線

Pressure Drop 壓力降

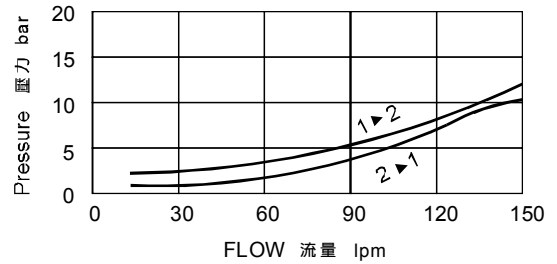

◆ SPECIFICATIONS 規 格

Model Number 型式號碼	Maximum Pressure 最大壓力 bar	Maximum Flow 最大流量 lpm	Weight 重量 Kg
VSV12-23	350 (5076 psi)	150 (39.63 gpm)	0.55 (1.21 lbs)
Fluid Type 流體型式		ISO VG 32, 46, 68	
Viscosity 黏性 cSt		10~400 (59~1854 SSU)	
Operating Temperature 操作溫度 °C		-30~100 (-22~212°F)	
Contamination Level 污染標準		ISO4406. 21/19/16 NAS1638,10	

◆ HOW TO ORDER 編號說明

1	2	3	4	5	6
VSV	12	— 23 —	A2	— X —	Y

1 VALVE SERIES 系列名稱

VSV=Cartridge Type Solenoid Operated Check Valves 插入式電磁止逆閥

2 SUBPLATE MOUNTING SIZE 稱呼口徑

Size:12
Cavity 孔口: CS12-2N
See Page Appendixes-A_001
見附錄A_001 頁面

3 CONTROL PORT(S) 動作形式

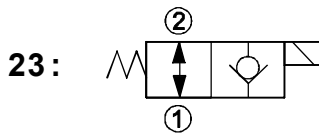

4 TYPE OF COIL 線圈類型

Non: Without Coil 無記號:無線圈
A1 : RAC110V 60/50HZ D1 : DC12V
A2 : RAC220V 60/50HZ D2 : DC24V

5 WIRING TYPE 接線型式

Non: WIRING BOX TYPE (DIN) X: DOUBLE LEAD 無:接線盒式 (DIN) 雙接線方式



※ For more technical information of wiring typt please refer to the appendixes-D or contact with us .
接線型式的詳細技術資料請查附錄-D或與我們聯繫.

6 ADJUSTMENT OPTION 調整選擇

Non	
Non:Standard 無記號:標準型	
Y	
Y:Push Style Manual Override 推壓型 - 手動操作復位	

◆ DIMENSIONS 外型尺寸圖

